

Article number: 46933543

Description: Torque limiter Synchron D 35 L

## Measures

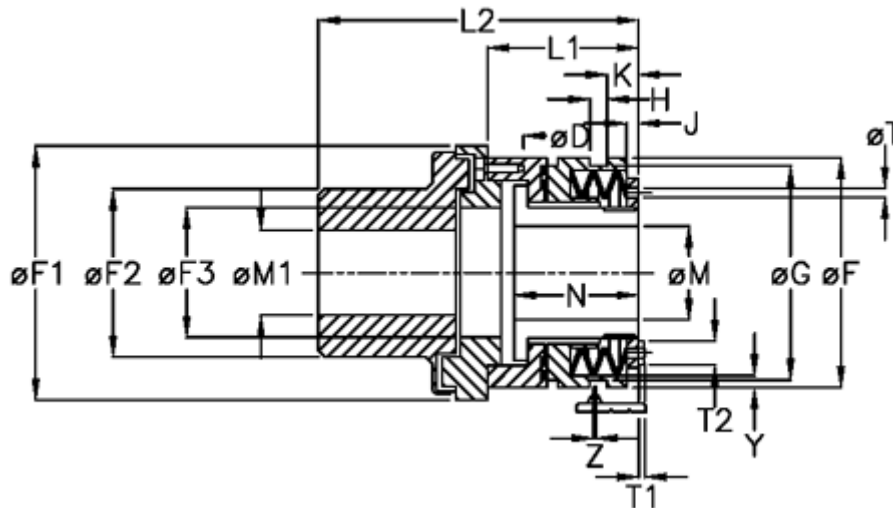

D	= 6xM6	H	= 9	T1	= 4.0
Disc spring mounting	= 5x1L	J	= 6.0	T2	= 10
Disc spring version	= L - heavy	K	= 12.0	Y	= 2
F	= 100	L1	= 61.0	Z	= 0.0
F1	= 112	L2	= 147.0		
F2	= 79	M1 max	= 50		
F3	= 60	M max	= 35		
G	= 91.0	M min	= 14		